

Mounting Options

Pistol Model	Accepts SRO	Mount Recommended
Glock® MOS	✓	Requires Mount #AC32085
Custom RMR Cut Glock®	✓	None needed
Smith & Wesson® M&P® C.O.R.E.™	✓	None needed
Springfield® 1XD(M)® OSP™	✓	Requires Mount #AC32085
Canik TP9SFX	✓	None needed
Walter® Q5 Match and PPQ Q4	✓	None needed
Custom Cut 1911 that accepts an RMR	✓	None needed
STI Models that take RMR	✓	None needed
Beretta APX	✓	None needed
CZ P10	✓	None needed
Standard 1911	✓	Requires CA428 and some modification by a gunsmith

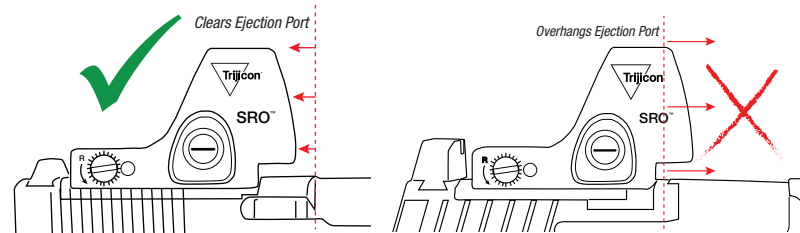

It is not recommended to mount SRO on pistols if the front of the optic overhangs the chamber/breach face as this may cause the pistol to malfunction.

Available Reticles

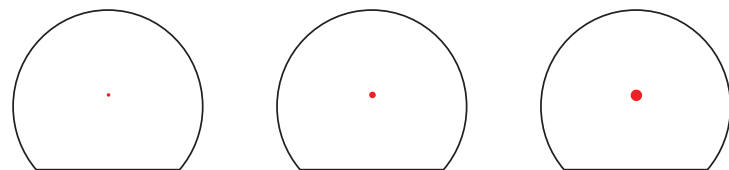

1.0 MOA Dot

Best Use:
Long Range and Bullseye Shooting

2.5 MOA Dot

Best Use:
Target Shooting, Competition, and Hunting

5.0 MOA Dot

Best Use:
Quick Close Shooting

Reticles not shown to scale. For a full view of reticles, and list of accessories please visit our website at Trijicon.com.

OPTIONAL ACCESSORIES

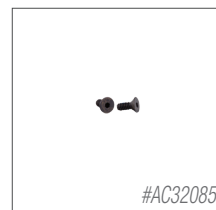

RMR® / SRO Mounting Kit - Fits Glock® MOS and Springfield OSP Models

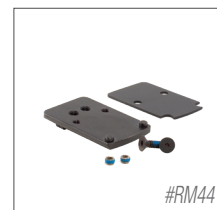

RMR® Pistol Mount for All Glock® Models (not including Glock MOS slides).



1911 RMR Mount w/ Integrated Night Sight Set

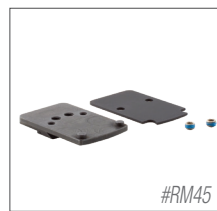

RMR Pistol Mount for Smith & Wesson M&P

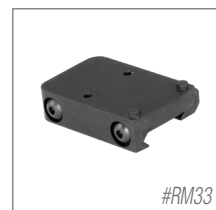

Picatinny Rail Mount Adapter for RMR - Low Profile

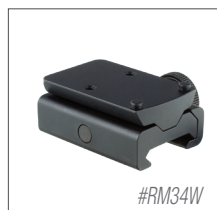

Weaver Rail Mount Adapter for RMR - Colt Thumb Screw

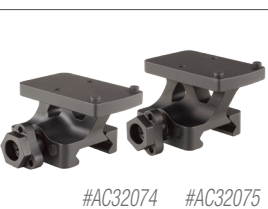

Full Co-Witness Quick Release Mount Lower 1/3 Co-Witness Quick Release Mount

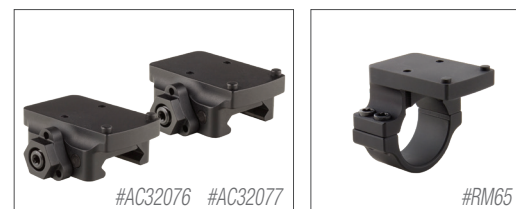

Low Quick Release Mount Low Weaver Quick Release Mount



RMR® Mount for 30mm Riflescope



Trijicon SRO®

Specialized Reflex Optic



The Trijicon SRO® is specifically designed for pistol use. The wide field of view and clean, crisp dot makes it easy for users to find and track the dot in both target and competitive shooting applications, helping improve shooting accuracy and speed. Every SRO features both manual and automatic LED brightness modes and a 3-year battery life. These features make the SRO a great choice in any application.

1 CLEARLY SEE THE TARGET

- Large, clear lens give the user an unobstructed field of view.
- Parallax free

2 FINDING AND TRACKING THE DOT IS EASY

- The large circular field of view helps you find the dot and center it in the lens when shooting.

3 EASILY MOUNTS TO POPULAR RED-DOT-READY PISTOLS

- The SRO shares the same foot print as the Trijicon RMR®.
- Also compatible with most RMR mounts.
- Does not require a sealing plate.

The Science of Brilliant®

At Trijicon, we are bound by a commitment to industry-leading research, design, and testing to seek innovative aiming solutions that constantly redefine "brilliant." That's why Trijicon products are subjected to the below testing methods.



Alaska-to-Africa Tested | Immersion Tested | Solid Zero Tested
Vibration Tested | Drop Tested

Visit Trijicon.com/Science to learn more.



Trijicon.com/SRO

©2020 Trijicon, Inc. | Wixom, Michigan USA | Phone: 1-800-338-0563 | info@trijicon.com
Specifications subject to change without notice. | PML4071 Rev(2-A) 1220

Features and Benefits

- A Easily Adjustable Windage & Elevation**
Tool-less design makes zeroing hassle-free.
- B Top-Loading Battery**
Battery changes are easy, with no need to unmount the optic; Uses common CR2032 battery.
- C Rugged, Durable Construction**
7075-T6 forged aluminum housing; waterproof up to 10 ft. (3m).
- D Large, Unobstructive Field of View**
Find the red dot with ease; parallax free.

- E Clear, Crisp Red Dot**
Finely tuned illuminated reticle, coupled with an exceptionally clear front lens, offer clear sight picture.
- F Intuitive, Easy-to-Adjust Illumination Controls**
8 brightness settings, including 1 super bright mode and 2 night vision modes.
- G Identical Footprint as RMR®**
Mounts easily on popular red-dot-ready pistols using the same base as Trijicon RMR®.

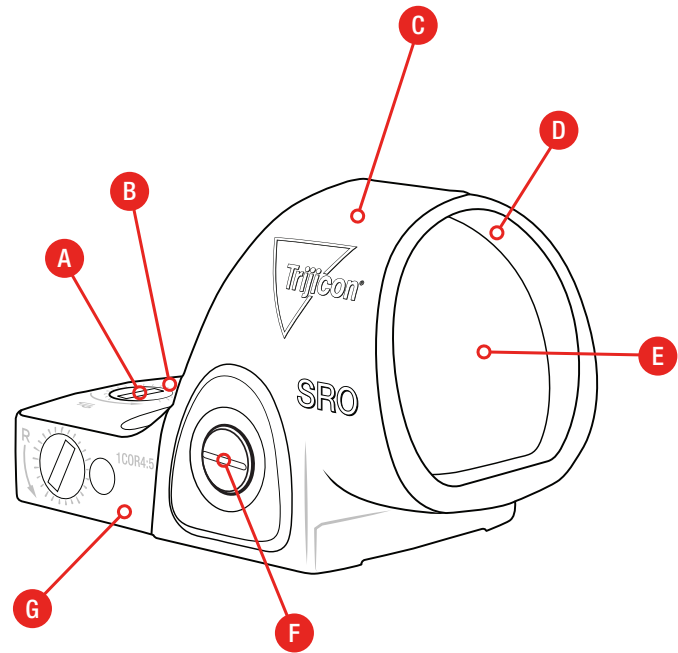

8 Brightness Settings Including 1 Super Bright Mode and 2 Night Vision Modes



Button "Lock-out" Mode: Secures the Auto-Brightness Setting Feature

- Ideal for everyday carry or hunting



NEW Button "Lock-in" Mode: Secures the User-Chosen Brightness Setting Indefinitely

- Ideal for competition and target shooting

SRO® / RMR® Comparison

FITS MANY POPULAR RED-DOT-READY PISTOLS



	SRO™	RMR® (Adjustable LED)
Magnification	1x	1x
Sight Window	.98 x .89 in. 25 x 22.5mm	.87 x .63 in. 22 x 16mm
Lens	Tempered Glass	Tempered Glass
Adjustments	1 click = 1 MOA	1 click = 1 MOA
Adjustment Range (Elevation & Windage)	150 MOA Total Travel	150 MOA Total Travel
Dimensions (L x W x H)	2.2 x 1.3 x 1.4 in. 55 x 32 x 34mm	1.8 x 1.2 x 1.0 in. 46 x 30 x 25mm
Weight	1.6 oz. (w/ battery) 46g	1.2 oz. (w/ battery) 34g
Illumination Source	LED Powered by CR2032 Battery	LED Powered by CR2032 Battery
Battery Life*	Over 3 years of continuous use (when used at 70°F (21°C)) at setting 4 of 8	Over 4 years of continuous use (when used at 70°F (21°C)) at setting 4 of 8
Brightness Settings	Automatic & 8 Adjustable Settings	Automatic & 8 Adjustable Settings

*Extreme temperatures (high or low) will affect lithium battery performance.

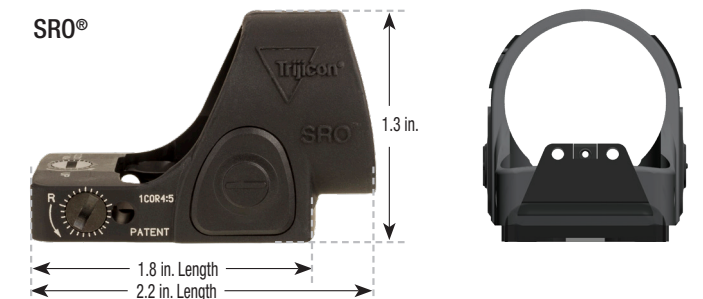

Mounts Easily Using the Same Base as the Trijicon RMR®

SRO

RMR