



HOLOSUN DRS-NV
Digital Rifle Sight – Night Vision
User Manual v1.2

CONTENTS

Important Notices	2
Product Overview	3
Features	4
Battery	4
1. Battery Installation (As shown in Figure 2)	4
2. Battery Recharging	5
Product Installation	5
Red Dot Sight Functions.....	6
1. Multi-Reticle System	6
2. Sight Operation	6
Camera Functions	7
1. Power On	7
2. Power Off	7
3. Camera Control Button (As Shown in Figure 8)	7
4. Menu Operation	9
Data processing	12
Reticle	12
Zero Setting.....	15
1. Fusion Calibration.....	15
2. Red Dot Sight Calibration	15
Lens Covers	16
Removing or Replacing the Camera.....	16
Included Tools.....	17
Maintenance & Care.....	17
1. Cleaning and Maintenance.....	17
2. Software Upgrade	17

Important Notices and Warnings

1. Ensure the firearm is unloaded and safe by removing all ammunition and magazines from the firearm and verify an empty chamber before installation and battery replacement. Do not attempt to install this sight kit on a loaded gun. Safe firearm handling rules should be followed at all times.
2. This product contains natural rubber latex, which may cause a potentially fatal allergic reaction! If you are allergic to rubber, it is important to strictly avoid products containing rubber.
3. If the product has been stored for an extended period, please check its functionality before using it.
4. Do not attempt to disassemble this product. Disassembly by anyone other than an authorized repair center could cause damage and will void the warranty.
5. For best performance do not touch optical surfaces with bare hands. Optical surfaces should always be kept clean.
6. Clean the lens surfaces using lens tissues or a clean microfiber cloth.
7. Condensation on optical surfaces can affect performance. Condensation occurs when the temperature or humidity changes as follows:
 - a. When moving the device from cold to warm environments or vice versa.
 - b. Environments with high humidity.

As the temperature of the device acclimates with the environmental temperature condensation disappears. Use a towel to wipe away any condensation before use.

8. Sand and sea water can damage the optical coatings.
9. Image performance depends on the scene and atmospheric conditions. Visibility of a scene can vary depending on the time of day due to the influence of ambient light and humidity which will affect contrast and therefore image performance.
10. Do not point the device directly at the sun.
11. This device amplifies light to improve low light visibility. Moonlight and starlight provide sufficient lighting in most cases, however, during periods where cloud cover blocks moonlight and starlight, an external infrared (IR) illumination source is needed. Holosun recommends our RAID light with IR head or one of our laser devices with IR illumination such as the Holosun IRIS, LE321, or LS321.
12. When left in storage for an extended period, batteries should be removed and stored in polyethylene bags to prevent contact with metal. (It is recommended to recharge the batteries every two to three months.)
13. Remove the batteries from the battery compartment before connecting the device to your PC, or it may cause computer damage.
14. When carrying or transporting the device, close the protective lens cap to avoid damage.
15. Carefully read this manual before use. Proper usage of this device is important for safe operation.
16. Please keep the packaging should you need to make a warranty claim.

Ensure proper eye relief is maintained when shooting larger calibers.

The user assumes all responsibility and liability for having DRS-NV/TH properly mounted to a firearm and using the DRS-NV/TH properly. Always check the condition of your mounting system prior to using your firearm.

LEGAL NOTICE: Before attaching the DRS-NV/TH to a weapon, check the legal regulations in your area. Adherence to firearms law is always the sole responsibility of the user.

Product Overview

1. Product Description

Thank you for purchasing the HOLOSUN DRS-NV digital fusion sight. The DRS-NV is a sight that integrates a red dot sight with a digital night vision camera, combining Holosun's red dot aiming technology with digital night vision capabilities. The DRS-NV can be used day and night with the night vision camera. The night vision sensor's spectral band provides improved visibility through smoke, dust, rain, smog, etc. and greatly improves the low-light and no-light performance of the traditional red dot sight. Before operation, please read the User's Manual carefully.

2. Introduction of DRS-NV components (Figure 1)

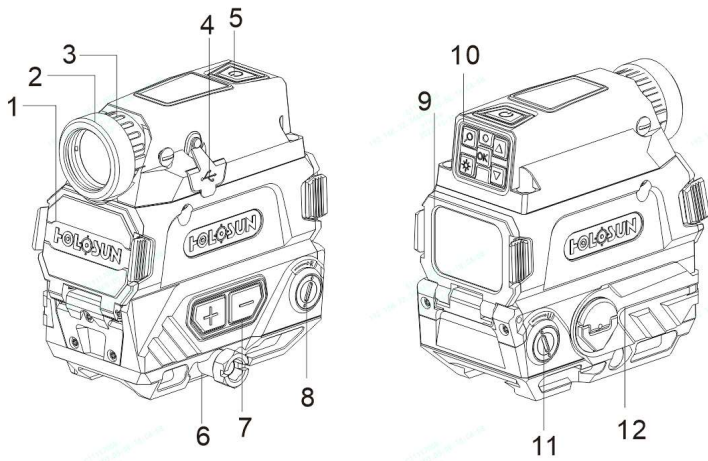

Figure 1. Introduction of components

Table 1. Description of components

No.	Description	No.	Description
1	Objective Lens Cover	7	Red Dot Sight Control Buttons
2	Night Vision Camera Lens Cover	8	Windage Adjustment for Red Dot Sight
3	Night Vision Camera Lens	9	Ocular Lens Cover
4	Magnetic Charging Port	10	Operation Buttons for NV Camera
5	Night Vision Power Switch	11	Elevation Adjustment for Red Dot Sight
6	Picatinny Mount	12	Battery Compartment

Features

Battery

1. Battery Installation (Figure 2)

- 1) Pull the paddle of the battery cover and rotate the paddle counterclockwise to open the battery cover.
- 2) Inspect the battery compartment for dirt, moisture, and corrosion. Clean the battery compartment if needed.
- 3) Inspect the O-ring seal on the battery cap to make sure that it is free of sand and dirt particles and that it has not been damaged.
- 4) Install the battery noting the "-" (negative) mark on the battery cap. Both batteries should be installed with the positive side facing inward.
- 5) Close the battery cap after installing the batteries. Press the battery cap firmly with your thumb and rotate the paddle clockwise until the battery cap is secured.

Note: The DRS-NV includes two 18350 batteries. You need to use the included dedicated USB magnetic cable or a high-quality battery charger for charging. Check the condition of the batteries frequently and do not use batteries that show signs of damage.

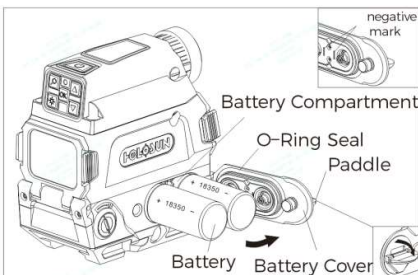

Figure 2

2. Battery Recharging

- 1) The recharging voltage of the DRS-NV is DC5V, and the required power is above 5V/2A.
- 2) Connect the USB end of the dedicated USB magnetic cable to an external USB power source, and then connect the other end of the cable to the magnetic charging port of the DRS-NV as shown in Figure 3.
- 3) Indicator light
 - a. Green indicator light flashes when charging.

b. After the battery is fully charged, the green indicator light is constant.

Note: If there are no batteries installed and the magnetic charging cable is connected, the indicator light will flash, and the DRS-NV power can be turned on. A battery icon will be displayed as confirmation (🔋).

Do not connect the magnetic USB charging cable when disposable batteries are installed.

Before charging, ensure the charging port is clean and wipe away any dust or debris.

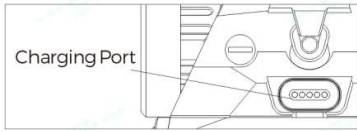

Figure 3

Product Installation

1. Use the included 11mm tool to loosen the nut by rotating counterclockwise. (Figure 4)
2. Move the clamping block to a position sufficient to connect the mount to a Picatinny rail.
3. Apply forward pressure to the DRS-NV and then tighten the 11mm mounting nut to 50-65 INCH/lbs.

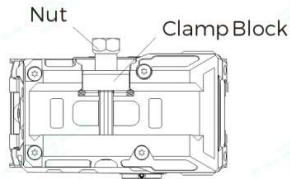

Figure 4

Red Dot Sight Functions

1. Multi-Reticle System

The reticle of this sight is a 2MOA dot centered in a 65MOA circle with four positioning points. The diameter of the circle reticle represents approximately 65 inches at 100 yards (170cm at 100 meters). The default reticle for this sight is a 2MOA dot centered in a 65MOA circle with four positioning points. Hold the "-" button down 3 seconds to switch between the three reticles (Circle +Dot, Dot only and Circle only) in that order. (As shown in Figure 5)

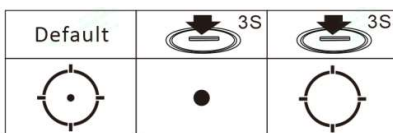

Figure 5

2. Red Dot Sight Operation

The "+" and "-" operation buttons are located on the left side of the DRS-NV.

- 1) Switch on: Momentarily press either brightness button ("+" or "-") to turn on the red dot sight. (As shown in Figure 6)
- 2) Power off: Press the "+" and "-" buttons simultaneously to turn the red dot sight OFF.
- 3) Operation mode: Two modes are available in the following order: Manual Mode -> Lockout Mode.
 - a. Manual mode:
Brightness adjustment: There are 12 reticle brightness setting levels in manual mode. Settings 1 to 4 are NV compatible and setting 12 is the brightest. Press "+" or "-" to increase or decrease the brightness
 - b. Lockout Mode:
Lock Mode Activation: Hold the "+" button for 3 seconds (until the LED blinks once) to activate Lock Mode. In lock mode, buttons are locked out preventing any setting changes. To deactivate Lock Mode, hold the "+" button for 3 seconds (until the LED blinks once) to confirm Lock Mode is deactivated.
- 4) Sleep timer setting:
 - a. Please note that your red dot will automatically enter into sleep mode after 10 minutes of no movement or operation.
 - b. The sight will instantaneously wake up to the last used settings from any minimal motion of the sight.
 - c. The default sleep timer setting is 10 min but can be adjusted to one of four settings.
 - i. Press and hold the "+" button for 10 seconds to enter sleep time adjustment mode. At the 10 second mark the reticle will blink indicating what setting is saved. There are 4 options: 10 min, 1h, 12h or the sleep mode is disabled.
 - ii. Press the "+" or "-" button to set the timer setting. The LED will blink (1 = 10 min, 2 = 1h, 3 = 12h, or 4 = disable sleep mode).
 - iii. Press the "+" and "-" buttons simultaneously to save the time setting and power off the sight.

Note:

- 1) Memory function: The sight will remember the last saved brightness setting when powered on and off.
- 2) Low Battery Warning: The reticle image will flash slowly, once a minute, to indicate when to replace the batteries.

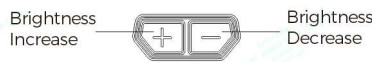



Figure 6

Camera Functions

1. Power On

Momentarily press the power button on top of the DRS-NV  to activate the digital night vision camera. You will see the following page: (As shown in Figure 7)

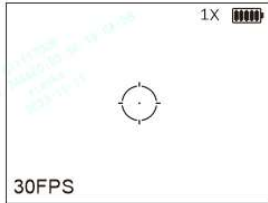





Figure 7

2. Night Vision Camera Power Off and Auto Off

Press and hold the top power button  for 2 seconds to turn off the night vision camera. While off, press and hold the top power button  for 5 seconds to enter the Auto Off activation mode. Momentarily press the  button for 1 second to activate or deactivate Auto Off. When the red indicator light flashes once every two seconds Auto Off is activated. When the red indicator light flashes three times Auto Off is deactivated. Press and hold for 5 seconds to exit the Auto Off activation mode. When Auto Off is activated, the DRS-NV will automatically power off after ten minutes of no movement. When movement is detected, the ten-minute timer restarts which prevents Auto Off during use. Momentarily press the power button to turn the night vision camera on.

3. Camera Control Buttons (As Shown in Figure 8)

Note: All Button and menu settings are automatically saved.

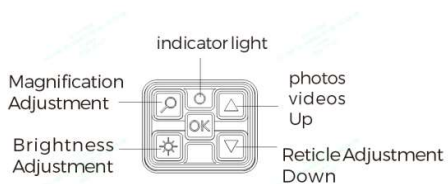







Figure 8

1) Taking Photos or Recording Video

Momentarily press the  button to take photos. The remaining memory space, represented as remaining percentage, will be displayed in the lower right corner of the screen. For example, 10%  means there is 10% of storage space remaining. Long press the  button to start video recording. When the video is being recorded the blue indicator light is constant and a dot flashes in the lower right corner of the screen. Press and hold again to exit camera mode. You can take photos during the video recording process by pressing  momentarily while recording. After taking photos or videos, the percentage of remaining storage space is displayed in the lower right corner of the screen.

2) Digital Reticle Adjustment

Short press the button  to adjust the brightness of the digital reticle. Select between Off → black → low light → high light → OFF. Press and hold the  button once to select from three different reticles. Switch between Crosshair → Circle-Dot → T-Reticle 1 → T-Reticle 2.



3) Magnification Adjustment

Momentarily press the  button to adjust the screen magnification. The default magnification is 1X and can cycle between 1x, 2x, 4x, and 8x in sequence. The magnification power and icon will display in the upper right corner of the screen.

4) Screen Brightness Adjustment

Press the  button to adjust the screen brightness cycling from setting 1 to setting 6. The current brightness setting number will be displayed in the lower right corner of the screen, for example setting 4 will display as OLEDBri4. The brightness setting value will disappear after 2 seconds.

5) Main Menu Settings

Long press the  button to deactivate or activate all symbols in the upper right corner of the screen. To enter the main menu, momentarily press the  button. While in the main menu screen, if no function is selected the

system will exit after 2 seconds.

6) Observation Mode

Observation mode disables photo and video functions extending battery life.

Press and hold the  button and then simultaneously press the power button to enter Observation Mode. In this mode photography and video recording cannot be used. An eye symbol will be displayed in the upper right corner of the screen. Power off the DRS to exit observation mode.







4. Menu Operation

Table 2. Description of menu options

First Level Menu		Secondary Menu	
Item	Function	Item	Function
IMG	Image Function	Bri	Image Brightness
		Crt	Contrast
		FPS	Frames Per Second
		Sharp	Sharpness
Cal	Gun Calibration Functions	Reti	Reticle Position
		OLED	Display Image Position
		Img	Camera image Position
Set	Restore Original Functionality and Formatting	Reset	Restore Factory Settings (except for red dot zero settings)
		FMT	Formatting





1) IMG (Image Function)

Set the image display effect based on changes in ambient lighting.

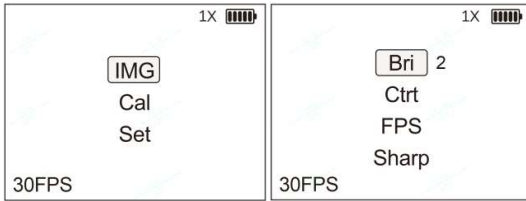



- a. Brightness: Press the  button to enter the main menu interface (IMG (Image) function is selected by default). Click the  button to enter the image setting interface (Bri (Brightness) function is selected by default), and then click the  button to set the image brightness. Select between 1 to 6 of image brightness using the  and  buttons to adjust the image brightness. After setting is selected, press and hold the  button.

button to return to the previous menu.







b. Contrast: From the IMG menu, press the  button to enter the Crt (Contrast) function. Click the  button to adjust Crt. There are 1 to 5 settings of Crt. Press the  and  buttons to adjust Crt. After selecting your contrast (Crt) setting, press and hold the  button to return to the previous menu.



c. Frames per Second: From the IMG menu, press the  button to enter the FPS function. Click the  button to set the FPS. The FPS has two settings: 30 and 60. Press the  and  buttons to adjust the FPS. After selecting your FPS, press and hold the  button to return to the previous menu.





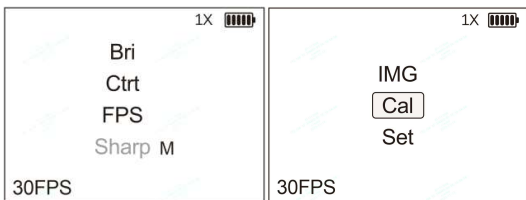



d. Sharpness: From the IMG menu, press the  button to enter the Sharp (Sharpness) function. Click the  button to set your Sharp setting. Sharp has three settings: H/M/L (High/Med/Low Sharpness). Press the  and  buttons to adjust Sharp. After selecting your Sharp setting, press and hold the  button to return to the previous menu.







2) Cal (Zero Calibration Function)

The Cal (Calibration) setting is used to set your zero and to adjust the projected image alignment with your sight picture.

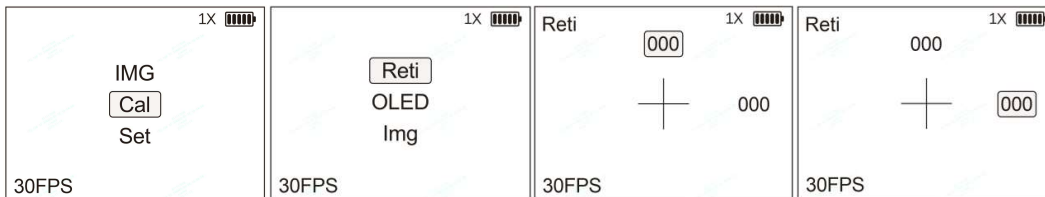
Press the  button to enter the main menu interface. Press the  button to select Cal, and then click the  button to enter the Cal settings interface.



a. Digital Reticle Zeroing: Click the  button to enter the Reti settings interface. Press the  and  buttons to adjust the horizontal (H: -150~150) and vertical (V: -150~150) parameters and adjust the reticle position. This adjustment will move the digital reticle to match your point of aim with your point of impact or co-witness with your red dot sight reticle.



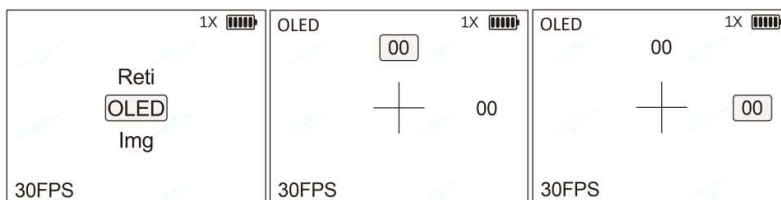

b. OLED Display Calibration: From the CAL menu, press the  button to select OLED, click the  button to enter the OLED settings interface. Press the  and  buttons to adjust the vertical (Y: -50~50) and horizontal (X: -50~50) parameters and adjust the display image position. The reticle and display images move synchronously during this calibration step.



e. Img (Image) Calibration: This is the preferred method to align the night vision camera image with the real-life image as viewed through the objective lens.

From the CAL menu, press the  button to select Img. Click the button  to enter the Img setting interface.

Press the  and  buttons to adjust the vertical (Y: -124~124) and horizontal (V: -93~93) parameters to adjust the camera image position. After this setting is completed, press and hold the  button to return to the previous menu.

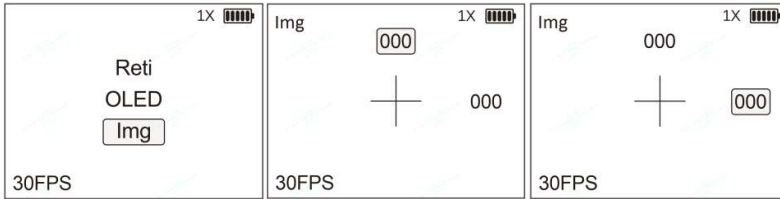

3) Set Function (Settings)

Press the button to enter the main menu interface. Press the button to select Set and press the button to enter the Set functions menu (Settings).

a. From the Set menu, press the button to enter Reset. Press the buttons and to select N or Y.

Selecting Y (Yes) will restore factory settings of the DRS-NV. To exit, press and hold the button to return to the previous menu.

b. From the Set menu, press the button to select FMT (Format). Press the button to enter the FMT settings interface. Press the buttons or to select N or Y. Selecting Y (Yes) will format the internal storage.

To exit, press and hold the button to return to the previous menu.

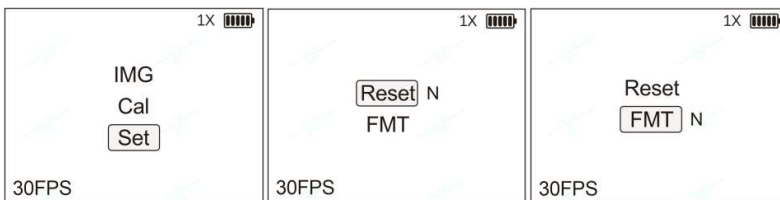

Data Processing

Exporting videos and images from the DRS-NV.

While OFF, connect the DRS-NV to your computer using the included magnetics USB interface cable. Turn on the DRS-NV. Your computer will automatically recognize the device's memory and then you can export video files and photos. The format of the video file is MP4, and the format of the photo is jpg. When finished, turn off the DRS-NV and then remove the USB interface cable.

Reticle

The DRS-NV has three types of reticles, and two custom reticle input functions are reserved for future expansion. Reticles will display a different scale depending on the magnification setting (1X, 2X, 4X, or 8X). Reticles are based on a 50 yard zero for 5.56 and 100 yard zero for .308. The following tables explain the three types of reticles and the scale.

1. The scale of the universal reticles at different magnifications: The numbers on the reticle represent 5MOA, 10MOA, 15MOA, and 20MOA, respectively.

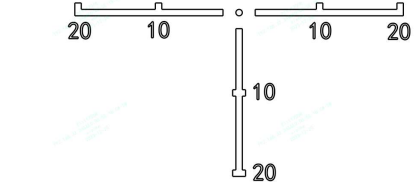
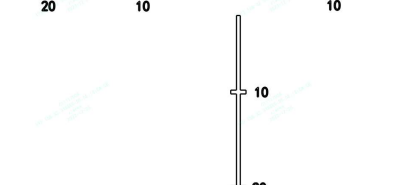
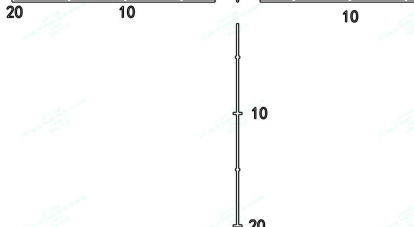
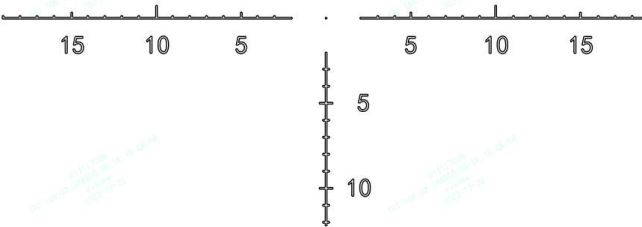
1X	
2X	
4X	
8X	

2. Example of the reticle for .308 caliber at different magnifications: The numbers on the reticle represent 200yard, 300yard, 400 yard, and 500yard, respectively.

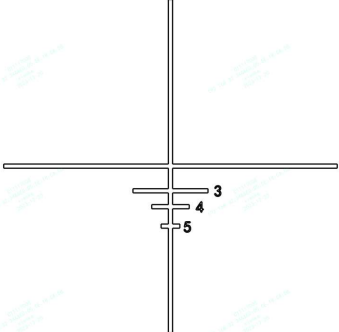
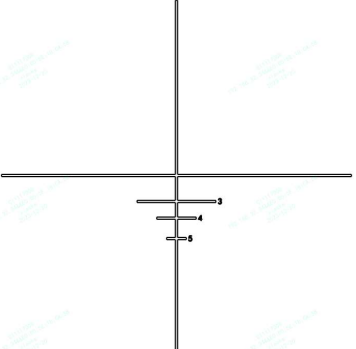
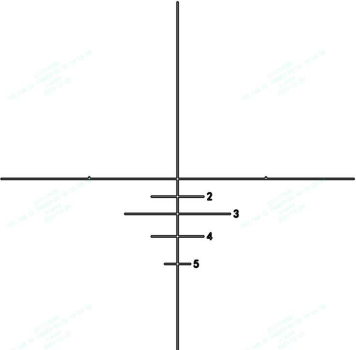
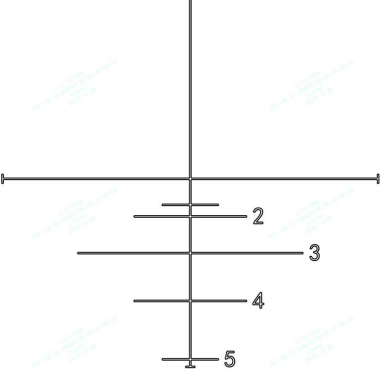
1X	 <p>A T-shaped reticle with a vertical central line and a horizontal line intersecting it. Below the intersection, there are three horizontal tick marks on the vertical line, labeled 3, 4, and 5 from top to bottom. The horizontal line is relatively narrow.</p>
2X	 <p>A T-shaped reticle similar to the 1X version, but the horizontal line is wider. The vertical line has three horizontal tick marks labeled 3, 4, and 5 below the intersection.</p>
4X	 <p>A T-shaped reticle with a significantly wider horizontal line. The vertical line has four horizontal tick marks labeled 2, 3, 4, and 5 below the intersection.</p>
8X	 <p>A T-shaped reticle with a very wide horizontal line. The vertical line has five horizontal tick marks labeled 2, 3, 4, and 5 below the intersection.</p>

3. The holdover T-reticle is designed around .223 caliber at different magnifications: The numbers on the reticle represent 200yard, 300yard, 400yard, and 500yard, respectively.

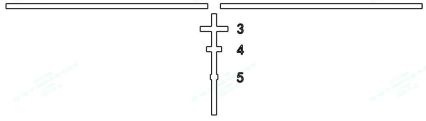
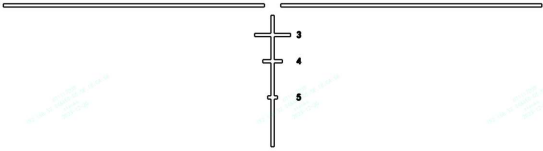
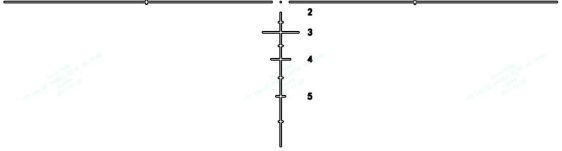
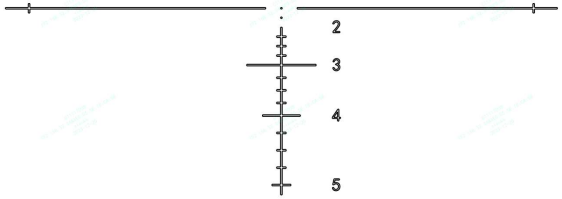
1X	
2X	
4X	
8X	

Zero Setting

1. Fusion Calibration: Aligning the red dot and the digital reticle.

- 1) **The fusion calibration of the camera image and the actual object image has been performed at the factory.**
- 2) During dusk and dawn periods, lighting is sufficient to obtain a sight picture through the objective lens with the digital night vision image overlay to enhance visibility. Confirm that the digital night vision image aligns with the real-life image at 30-50 meters using the 1X setting. Using a 3X magnifier (HOLOSUN HM3X) can be used to achieve the best results.

2. Red Dot Sight Calibration

- 1) After fusion calibration, perform red dot sight zeroing.
- 2) The red dot sight has been mechanically zeroed at the factory to approximately 25 meters.
- 3) The Elevation adjustment is located on the right side of the housing and the windage adjustment is located on the left side of the housing. Adjustments can be made using the included tools. (As shown in Figure 10)

4) 0.5 MOA Windage & Elevation adjustments, per click.

Each adjustment click has a value of approximately 0.5 MOA or 1/2 inch at 100 yards (1/4" at 50y; 1/8" at 25y). When zeroing at 50 yards, if your point of impact is 2 inches low and 1 inch right, you will need to adjust Elevation 8 clicks UP (clockwise) and windage 4 clicks LEFT (counter-clockwise).

5) The maximum adjustment range is ± 50 MOA.

6) After zeroing, adjust the digital reticle to the red dot position, turn off the red dot, and use the digital reticle for shooting verification or fine-tuning the digital reticle zero.

If you feel the windage or elevation adjustments can no longer be rotated, you may have reached the mechanical limit of the adjustment turret. Do not try to rotate the knobs further if you feel a bind or you may cause damage.

If you exceed the adjustment range, please contact your gunsmith or Holosun for assistance.

Note: If the night vision camera is removed or replaced, image fusion calibration is required.

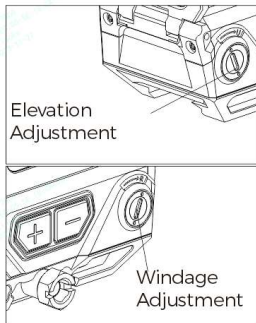

Figure10

Lens Covers

1. The DRS-NV includes lens covers for the red dot sight objective lens (solid), ocular lens (transparent), and digital night vision camera lens (transparent). When the solid lens cover of the objective lens is closed, the digital camera function of the DRS-NV will not be affected and may enhance contrast in certain lighting conditions.

2. To open the front and rear lens covers of the red dot sight, press the latches on both sides of the lens covers inward and the lens covers open. (As shown in Figure 11)

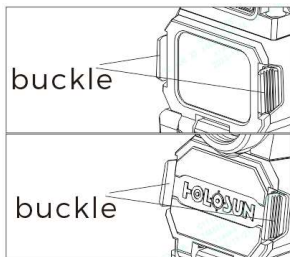

Figure 11

Removing or Replacing the Camera

Note: It is recommended to remove the camera only when necessary. If disassembly is required please follow the instructions and perform the removal and replacement in a clean indoor desktop environment.

1. To remove the camera, use the included T10 tool to remove the four screws by rotating counterclockwise and then remove the four screws 1 # ->2 # ->3 # ->4 # in sequence. Remove the camera installed on the upper part of the red dot sight. Take note of the screw size difference between the front screws and rear screws.

2. Keep the connector contacts clean. Do not touch the contacts with your hands. If the contacts are accidentally contaminated, use a clean alcohol cotton to wipe to clean the contacts several times.

3. Replace the camera seating it properly according to the locating pins. Then press the camera and lower housing together, especially the conductive connection base, as vertically and tightly as possible to maintain pressure between the camera and the lower housing. Use a T10 tool to reinstall the four screws. It is recommended to install in this sequence: #4 ->#3 ->#2 ->#1. Lastly, tighten the screws in a crisscross pattern to 15 inch/lbs, keeping the gap between the camera and the body consistent as you tighten the screws. (As shown in Figure 12)

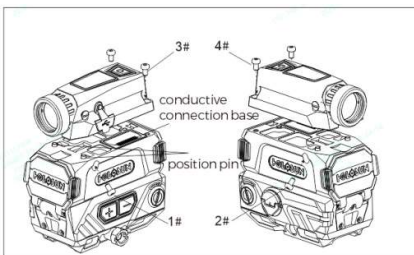

Figure 12

Included Tools:

1. T10 Torx tool with flat driver to adjust windage & elevation. (Figure 13)
2. 11mm Hex Wrench.



Figure 13

Maintenance & Care

1. Cleaning and Maintenance

1) This device is a precision instrument that deserves reasonably cautious care. The following tips are provided to ensure a long product life. The optical lenses are multicoated optical glass. When cleaning the lenses, blow away dust on the surface, wet the lens with lens cleaner or clean water, then wipe away smudges with lens tissue, soft cotton, or a microfiber cloth. Avoid touching the glass surface with dry cloth or tissue paper. Do not use organic solvents such as alcohol or acetone. No special maintenance is needed for the housing surface. Do not try to dismantle the device as the internal parts are specially cleaned and sealed and with an anti-fog treatment. Any such attempt will void the warranty.

2) If there is a shutdown phenomenon during use, please check whether the surface of the gold-plated parts in the battery compartment is contaminated.

3) If the screen flickers during use, please clean the connector contacts according to the instruction from the section "Removing or Replacing the Camera".

2. Software Upgrade

Download the upgrade file package to your computer and connect the device to your computer using the included magnetic USB cable. After the device is turned on, copy the upgrade file to the storage root directory of the device (the upgrade file name must be artosyn-upgrade-ars31.img) and then shut down the device. Hold the top right button without releasing it, and then press the power button to perform a software upgrade. The blue indicator light flashes during the software upgrade. After the flashing ends, the upgrade is complete.

Limited Warranty

Holosun DRS models include a limited lifetime warranty on parts and workmanship to the original purchaser. The lifetime warranty is limited to the housing and optical systems. Holosun provides a 3-year warranty from the date of original retail purchase for electronic components. At our sole discretion, we will repair or replace products found to be defective under normal use without charge, excluding any delivery costs which will be assumed by the purchaser. We will not be liable for incidental, consequential, or special damages arising out of or in any connection with the use or performance of this product. This warranty is void if the product has been misused, modified, neglected, or disassembled prior to its return. Please refer to www.holosun.com for current and complete warranty information and other conditions.